

## Magnetic Field Sensors

Contact Rollco for CAD-files.

Dimensions in mm.

**Ambient Temperature (°C):** -10 ~ +70

**Sensor Type:** GMR sensor

**Switching function:** NC/NO

**Max. Switching Current (mA):** 200x.

**Switching Frequency (Hz):** 1000

**Voltage drop:** 1.5 V / 200 mA max.

**Protection Class:** IP67

**Electrical connection:** M8, 3-pin

**Extension cable:** Energy chain compliant

**Cable material length:** PU - 0.3 m

**Output:** PNP

**Operating Voltage (V DC):** 10 ~ 28

**Max. Power Rating (W):** 5.5 max.

**Current consumption:** 10 mA / 24 V max.

**Shock/vibration:** 50 G / 9 G

**LED indicator:** Yellow



## MTJ / MRJ / MTV

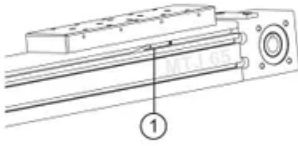

1. Magnetic field sensor
2. Sensor holder

## CTV / CTJ

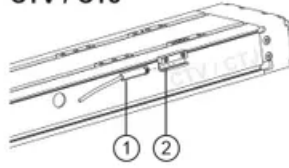





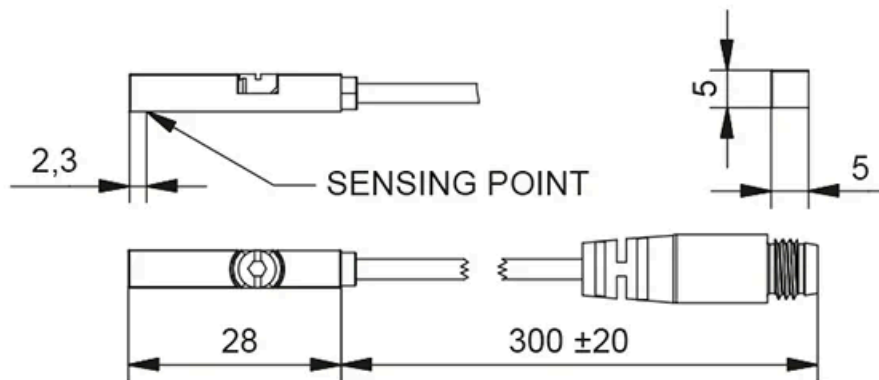



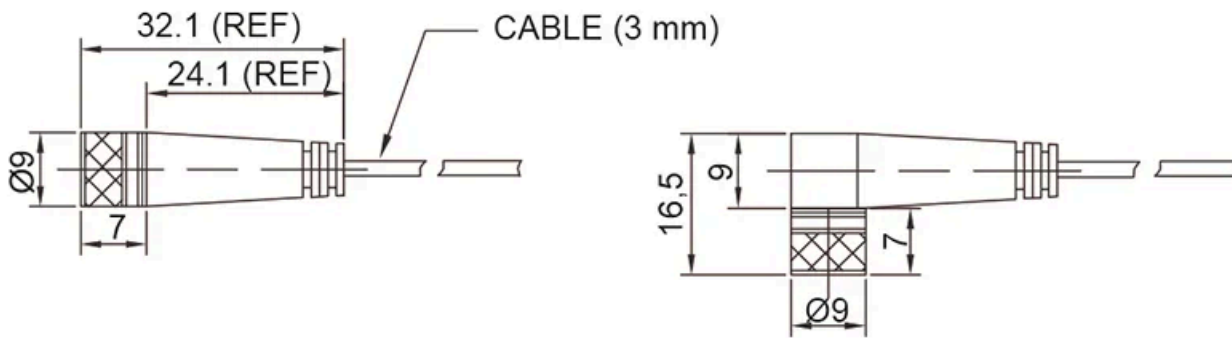

Mounting of magnetic field sensor on CTV and CTJ series requires a HOM sensor holder. For CTV/CTJ 200 a HOM sensor holder is not needed

**General Data**



**Extension cable with connector**



Type	Compatibility	
HOM Sensor holder	CTV 90, 110, 145 CTJ: 90, 110, 145	
SMT-65TP-K NC	MTJ / MRJ / MTV / MTJZ: 40, 65, 80, 110 CTV / CTJ: 200	
SMT-65TP-K NC+HOM	CTV 90, 110, 145 CTJ: 90, 110, 145	
SMT-65TP-K NO	MTJ / MRJ / MTV / MTJZ: 40, 65, 80, 110 CTV / CTJ: 200	
SMT-65TP-K NO+HOM	CTV 90, 110, 145 CTJ: 90, 110, 145	
Extension Cable length 2m - Straight connector		
Extension Cable length 5m - Straight connector		
Extension Cable length 2m - Angeled connector		
Extension Cable length 5m - Angeled connector		

Designation	Compatible with
HOM Sensor holder - 43851	CTV 90, 110, 145CTJ: 90, 110, 145
SMT-65TP-K NC - 74073	MTJ / MRJ / MTV / MTJZ:40, 65, 80, 110 CTV / CTJ: 200
SMT-65TP-K NC - 77075	CTV 90, 110, 145CTJ: 90, 110, 145
SMT-65TP-K NO - 74074	MTJ / MRJ / MTV / MTJZ:40, 65, 80, 110 CTV / CTJ: 200
SMT-65TP-K NO - 77076	CTV 90, 110, 145CTJ: 90, 110, 145
Extension Cable length 2m - Straight connector - 8146	-
Extension Cable length 5m - Straight connector - 8147	-
Extension Cable length 2m - Angeled connector - 9017	-
Extension Cable length 5m - Angeled connector - 9019	-