

Linear Unit MTV 110

The MTV series describes linear units with precision ball screw drive, integrated guide rail and compact dimensions. The units use a precision ball screw, with tolerance class ISO7 (ISO5 on request), with reduced backlash of the ball nut. A corrosion-resistant protection strip, protects all the parts in the profile from dust and other contaminants.

To achieve higher speeds at the same stroke of the linear unit, the ball screw support system can be integrated. With this feature vibrations and deflections of the ball screw are reduced, therefore longer strokes are possible. The linear unit with integrated support system can have a higher axial load capacity. Ball screw supports are made of high quality plastic materials with high wear resistance properties. The system enables ball screw support in horizontal or vertical positioning of the linear unit.

A 2LR version of MTV linear unit is available, where two carriages are moving simultaneously in opposite directions. Both right- and left-handed precision ball screws are used, which are rigidly connected. The ball screw support system can also be integrated.

Dimensions in mm.

- Modulus of Elasticity:** $E = 70000 \text{ N / mm}^2$
- Operating Temperature (°C):** 0 ~ +60 For operating temperature out of the presented range, please contact Rollco.
- Duty Cycle:** 100%
- Max. Acceleration (m/s²):** 20

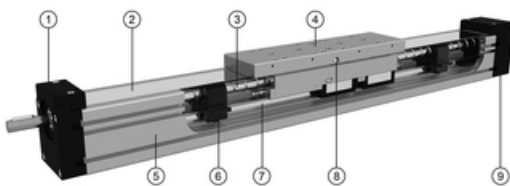

1. Drive block with floating bearing (MTV 110 - fixed bearing)
2. Corrosion-resistant protection strip
3. Ball screw tolerance ISO7 (ISO5 available on request)
4. Carriage with built in magnets
5. Aluminium profile - hard anodized
6. Screw support - SA
7. Integrated linear ball guideway
8. Central lubrication port, both sides
9. End block with fixed bearing (MTV 110 - floating bearing)

Deflection of the linear unit (standard)

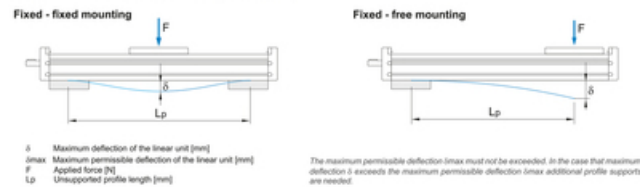

Deflection of the linear unit

MTV 110

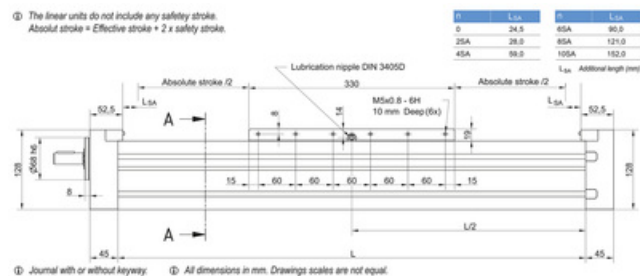
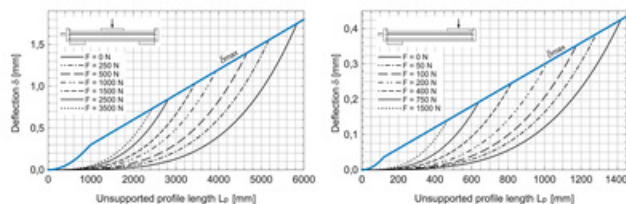

Linear Unit MTV 110

① The linear units do not include any safety stroke.
 Absolute stroke = Effective stroke + 2 x safety stroke.

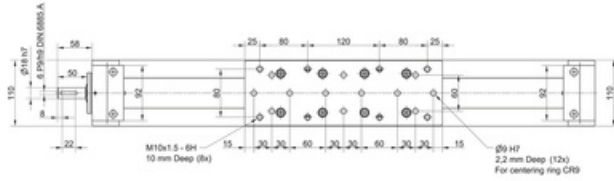

① Journal with or without keyway. ② All dimensions in mm. Drawings scales are not equal.

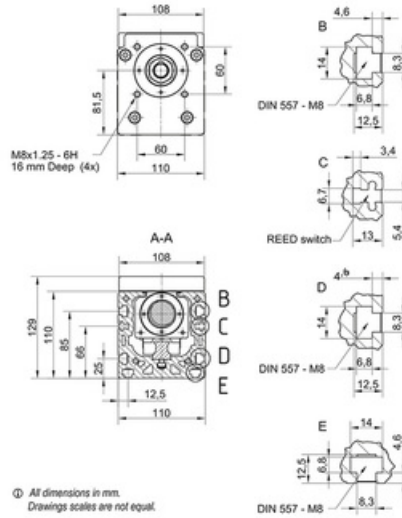

① All dimensions in mm.
 Drawings scales are not equal.

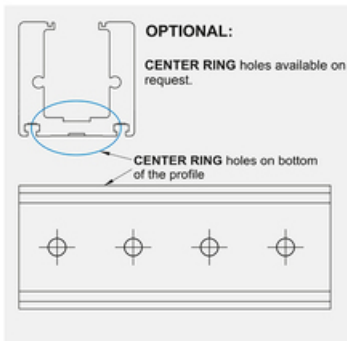

Mounting the drive

- by the MOTOR SIDE DRIVE - MSD
- by the MOTOR ADAPTER WITH COUPLING

Defining of the linear unit length

$$L = \text{Effective stroke} + 2 \times \text{Safety stroke} + L_v + 2 \times L_{SA} + 15 \text{ mm}$$

$L_v = 330 \text{ mm}$

$$L_{\text{total}} = L + 90 \text{ mm}$$

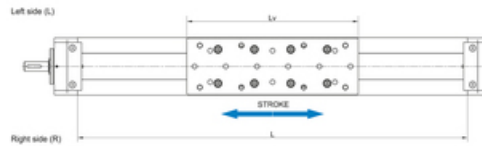

Maximum travel speed as a function of the profile length (vmax - L curves)

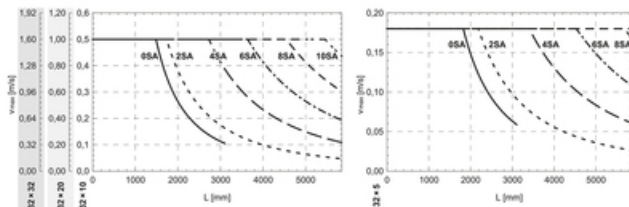

Exceptions for standard version

Linear Unit	Number of SA nSA	Max length Lmax (mm)	Max stroke (mm)
MTV 110	0	3100	2706

Stated values in the table apply only for horizontally orientated unit.

General Data

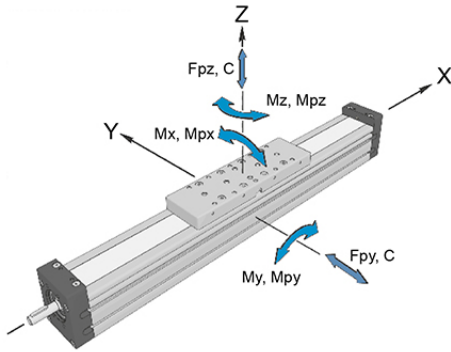

For lengths/stroke over the stated value please contact us. Values for max. stroke are not valid for screw support SA. For the case of the SA the equation of defining the linear unit length (for particular size of the linear units) needs to be used.

Recommended values of loads

All the data of static and dynamic moments and load capacities are theoretical without considering any safety factor. The safety factor depends on the application and its requested safety. We recommend a minimum safety factor ($f_s = 5.0$).

Designation	Carriage Length L_v (mm)	Dynamic Load Capacity C (N)	Static Load Capacity C_0 (N)	Dynamic Moment M_x (Nm)	Dynamic Moment M_y (Nm)
MTV 110 - 32 x 5	330	49600	85000	630	2650
MTV 110 - 32 x 10	330	49600	85000	630	2650
MTV 110 - 32 x 20	330	49600	85000	630	2650
MTV 110 - 32 x 32	330	49600	85000	630	2650

Designation	Dynamic Moment M_z (Nm)	Max. Permissible Loads Forces F_{py} (N)	Max. Permissible Loads Forces F_{pz} (N)	Max. Permissible Loads Moments M_{py} (Nm)	Max. Permissible Loads Moments M_{pz} (Nm)	Max. Length L_{max} (mm)
MTV 110 - 32 x 5	2650	10000	20260	670	535	5850
MTV 110 - 32 x 10	2650	10000	20260	670	535	5850
MTV 110 - 32 x 20	2650	10000	20260	670	535	5850
MTV 110 - 32 x 32	2650	10000	20260	670	535	5850

Designation	Max. Stroke (mm)	Min. Stroke (mm)
MTV 110 - 32 x 5	5456	65
MTV 110 - 32 x 10	5456	65
MTV 110 - 32 x 20	5456	65
MTV 110 - 32 x 32	5456	70

Drive Data

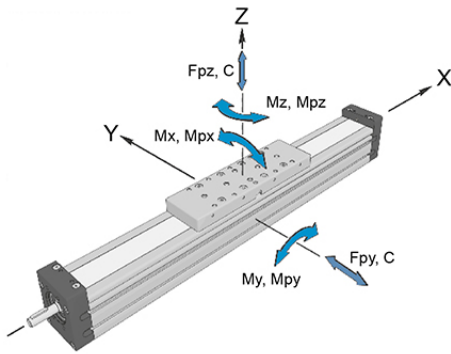

- With SA or 2LR version the max. rotation speed is limited to 3000 rev/min.
- Max. travel speed depends of the length of the linear unit, see diagram for particular size of the linear unit. For travel speed over the stated value, please contact Rollco.
- For the ball nut with the preload of 2%, please contact Rollco.
- In the case of 2RL version the axial load is total axial load of both carriages.
- For minimum stroke below the stated value, please contact Rollco.

Max. acceleration (m/s²): 20*

For acceleration over the stated value, please contact Rollco.

Reduced effective diameter at journal with keyway decreases values of max. drive torque.

Designation	Max. Rotational Speed (without SA) (rev/min)	Max. Travel Speed (without SA) (m/s)	Lead Constant (mm/rev)	Ball Screw (d x l)	Max. Repeatability Precision Standard ISO7
MTV 110 - 32 x 5	2150	0.18	5	32 x 5	±0.02
MTV 110 - 32 x 10	3000	0.50	10	32 x 10	±0.02
MTV 110 - 32 x 20	3000	1.00	20	32 x 20	±0.02
MTV 110 - 32 x 32	3000	1.60	32	32 x 32	±0.02

Designation	Max. Repeatability Precision ISO5	Dynamic Load Capacity BS Ca (N)	Max. Axial Load Fx (N)	Max. Drive Torque Ma (Nm)	Planar Moment of Inertia Iy (cm ⁴)	Planar Moment of Inertia Iz (cm ⁴)
MTV 110 - 32 x 5	±0.01	18850	18850	16.7	562	669
MTV 110 - 32 x 10	±0.01	33400	29600	52.3	562	669
MTV 110 - 32 x 20	±0.01	29700	14800	52.3	562	669
MTV 110 - 32 x 32	±0.01	35150	9240	52.3	562	669

Mass and Mass Moment

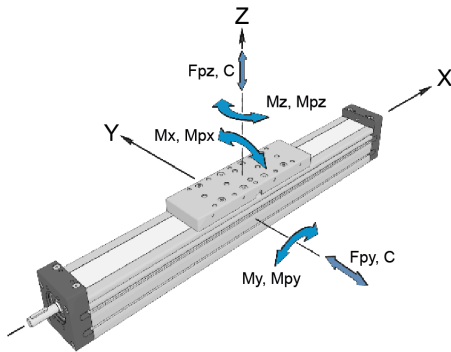

The stated values are for strokes up to 500 mm.
No load torque value increases with stroke elongation.

Mass calculation does not include mass of motor, reduction gear, switches and clamps.

Abs. stroke	Absolute stroke [mm]
A	Distance between carriages [mm]
nc	Number of carriages

Designation	Ball Screw (d x l)	Number of SA nSA	Mass of Linear Unit (kg)	Moved Mass (kg)	Mass Moment of Inertia (10 ⁻⁵ kg m ²)
MTV 110 - 32 x 5	32 x 5	0 ; 2 ; (4 ; 6 ; 8 ; 10)	17.3 + 0.0216 × (Abs. Stroke + (nc - 1) × A) + 4.9 × (nc - 1); 17.7 + 0.0216 × (Abs. Stroke + (nc - 1) × A) + 4.9 × (nc - 1); 19.3 + 0.8 × (nSA - 4) + 0.0216 × (Abs. Stroke + (nc - 1) × A) + 4.9 × (nc - 1)	4.90 + 4.90 × (nc - 1); 5.03 + 4.90 × (nc - 1); 5.29 + 0.065 × (nSA - 4) + 4.90 × (nc - 1)	34.6 + 0.0690 × (Abs. Stroke + (nc - 1) × A) + 0.31 × (nc - 1); 35.1 + 0.0690 × (Abs. Stroke + (nc - 1) × A) + 0.31 × (nc - 1); 39.4 + 2.2 × (nSA - 4) + 0.0690 × (Abs. Stroke + (nc - 1) × A) + 0.31 × (nc - 1)
MTV 110 - 32 x 10	32 x 10	0 ; 2 ; (4 ; 6 ; 8 ; 10)	17.3 + 0.0216 × (Abs. Stroke + (nc - 1) × A) + 4.9 × (nc - 1); 17.7 + 0.0216 × (Abs. Stroke + (nc - 1) × A) + 4.9 × (nc - 1); 19.3 + 0.8 × (nSA - 4) + 0.0216 × (Abs. Stroke + (nc - 1) × A) + 4.9 × (nc - 1)	4.90 + 4.90 × (nc - 1); 5.03 + 4.90 × (nc - 1); 5.29 + 0.065 × (nSA - 4) + 4.90 × (nc - 1)	35.5 + 0.0690 × (Abs. Stroke + (nc - 1) × A) + 1.24 × (nc - 1); 36.1 + 0.0690 × (Abs. Stroke + (nc - 1) × A) + 1.24 × (nc - 1); 40.4 + 2.2 × (nSA - 4) + 0.0690 × (Abs. Stroke + (nc - 1) × A) + 1.24 × (nc - 1)
MTV 110 - 32 x 20	32 x 20	0 ; 2 ; (4 ; 6 ; 8 ; 10)	17.3 + 0.0216 × (Abs. Stroke + (nc - 1) × A) + 4.9 × (nc - 1); 17.7 + 0.0216 × (Abs. Stroke + (nc - 1) × A) + 4.9 × (nc - 1); 19.3 + 0.8 × (nSA - 4) + 0.0216 × (Abs. Stroke + (nc - 1) × A) + 4.9 × (nc - 1)	4.90 + 4.90 × (nc - 1); 5.03 + 4.90 × (nc - 1); 5.29 + 0.065 × (nSA - 4) + 4.90 × (nc - 1)	39.3 + 0.0690 × (Abs. Stroke + (nc - 1) × A) + 4.96 × (nc - 1); 39.9 + 0.0690 × (Abs. Stroke + (nc - 1) × A) + 4.96 × (nc - 1); 44.4 + 2.2 × (nSA - 4) + 0.0690 × (Abs. Stroke + (nc - 1) × A) + 4.96 × (nc - 1)
MTV 110 - 32 x 32	32 x 32	0 ; 2 ; (4 ; 6 ; 8 ; 10)	17.3 + 0.0216 × (Abs. Stroke + (nc - 1) × A) + 4.9 × (nc - 1); 17.7 + 0.0216 × (Abs. Stroke + (nc - 1) × A) + 4.9 × (nc - 1); 19.3 + 0.8 × (nSA - 4) + 0.0216 × (Abs. Stroke + (nc - 1) × A) + 4.9 × (nc - 1)	4.90 + 4.90 × (nc - 1); 5.03 + 4.90 × (nc - 1); 5.29 + 0.065 × (nSA - 4) + 4.90 × (nc - 1)	47.0 + 0.0690 × (Abs. Stroke + (nc - 1) × A) + 12.71 × (nc - 1); 47.8 + 0.0690 × (Abs. Stroke + (nc - 1) × A) + 12.71 × (nc - 1); 52.8 + 2.3 × (nSA - 4) + 0.0690 × (Abs. Stroke + (nc - 1) × A) + 12.71 × (nc - 1)

Mass and Mass Moment

Designation	No Load Torque (Nm)	Planar Moment of Inertia Iy (cm ⁴)	Planar Moment of Inertia Iz (cm ⁴)
MTV 110 - 32 x 5	$0.60 + 0.60 \times (nc - 1); 0.67 + 0.60 \times (nc - 1); 0.81 + 0.035 \times (nSA - 4) + 0.60 \times (nc - 1)$	562	669
MTV 110 - 32 x 10	$0.70 + 0.70 \times (nc - 1); 0.84 + 0.70 \times (nc - 1); 1.12 + 0.070 \times (nSA - 4) + 0.70 \times (nc - 1)$	562	669
MTV 110 - 32 x 20	$0.75 + 0.75 \times (nc - 1); 1.03 + 0.75 \times (nc - 1); 1.60 + 0.140 \times (nSA - 4) + 0.75 \times (nc - 1)$	562	669
MTV 110 - 32 x 32	$0.80 + 0.80 (nc - 1); 1.25 + 0.80 \times (nc - 1); 2.16 + 0.225 \times (nSA - 4) + 0.80 \times (nc - 1)$	562	669